

TIMKEN**The Timken Company**

4500 Mt Pleasant St. NW

N. Canton, OH 44720

Phone: (234) 262-3000

E-Mail: CustomerCAD@timken.com • Web site: www.timken.com

Part Number 3208 ATN1/C3, Timken® Double Row Angular Contact Ball Bearings (3200, 3300)

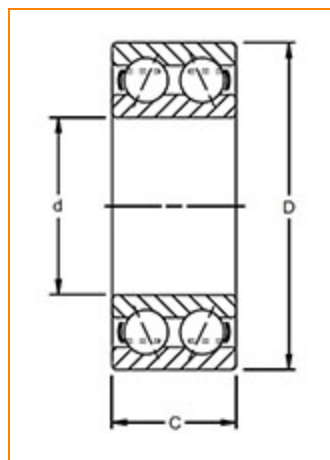

[Dimensions](#) | [Specifications](#) | [Basic Load Ratings](#) | [Abutment and Fillet Dimensions](#)

Dimensions

d - Bore	40.00 mm 1.5748 in
D - Outer Diameter	80.00 mm 3.1496 in
C - Ring Width	30.2 mm 1.1890 in
Contact Angle	30 °

Specifications

Features	Open
Ball Type	STEEL



Cage Type	Molded
Cage Material	Nylon
Bearing Weight	0.61 Kg 1.347 lb
Design Units	METRIC

Basic Load Ratings

C0 - Static Radial Rating	31800 N 7147 lbf
C1 ISO - Dynamic Radial Rating	40300 N 9058 lbf

Abutment and Fillet Dimensions

R - Inner Ring "To Clear" Radius ¹	1.10 mm 0.043 in
r - Outer Ring "To Clear" Radius ²	1.10 mm 0.043 in
da - Inner Ring Backing Diameter	47.0 mm 1.850 in
Da - Outer Ring Backing Diameter	73.0 mm 2.874 in

¹ Maximum housing fillet radius that bearing corners will clear.

² Maximum shaft fillet radius that bearing corners will clear.

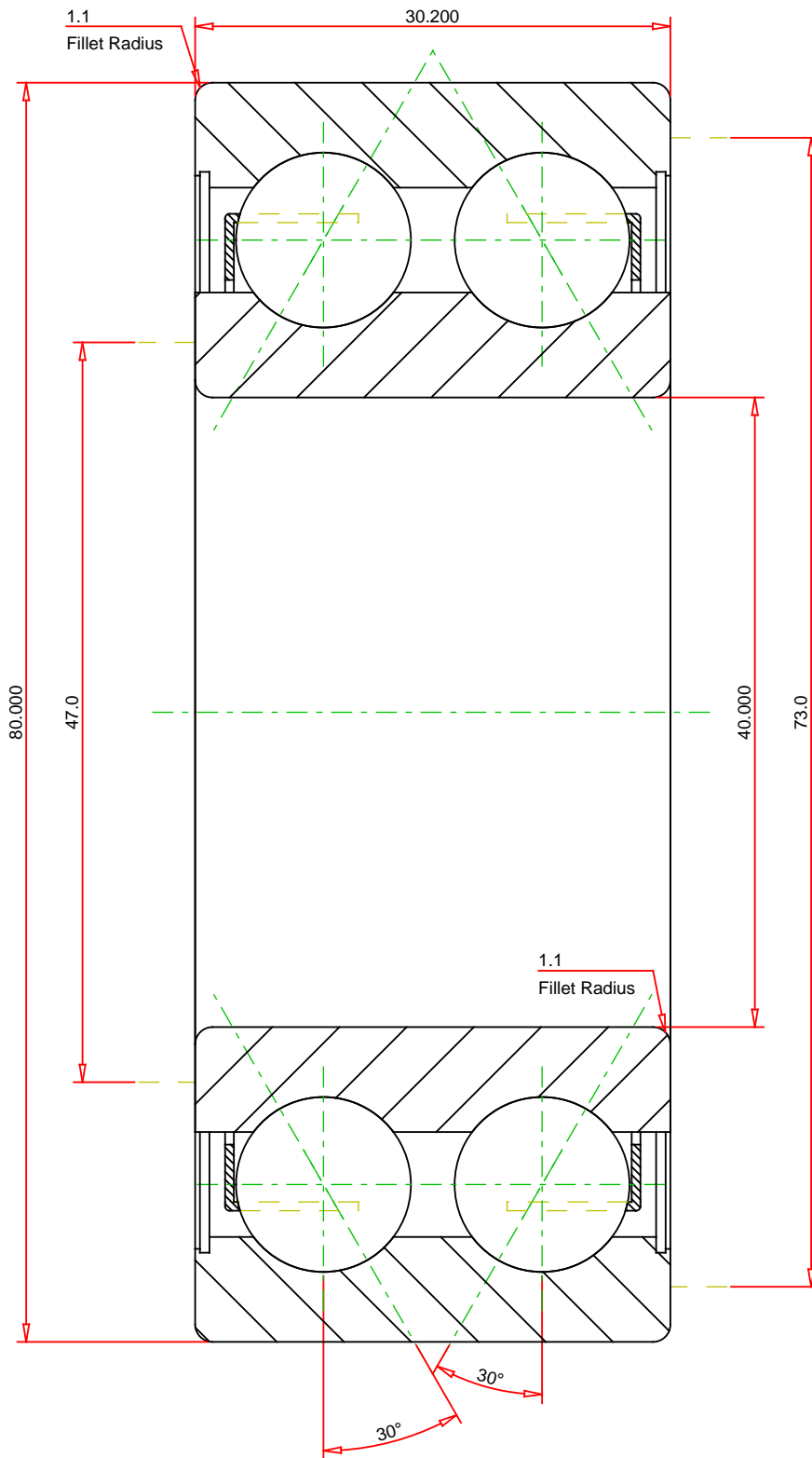

METRIC UNITS

Number of Balls Per Row	10
Bearing Weight	0.610 kg

TIMKEN®

THE TIMKEN COMPANY
NORTH CANTON, OHIO USA

3208 ATN1/C3	
Timken® Double Row Angular Contact Ball Bearings (3200, 3300)	
Dynamic Load Rating	40300 N
Static Load Rating	31800 N

Every reasonable effort has been made to ensure the accuracy of the information contained in this writing, but no liability is accepted for errors, omissions or for any other reason.

FOR DISCUSSION ONLY